

Vector systems based on animal viruses

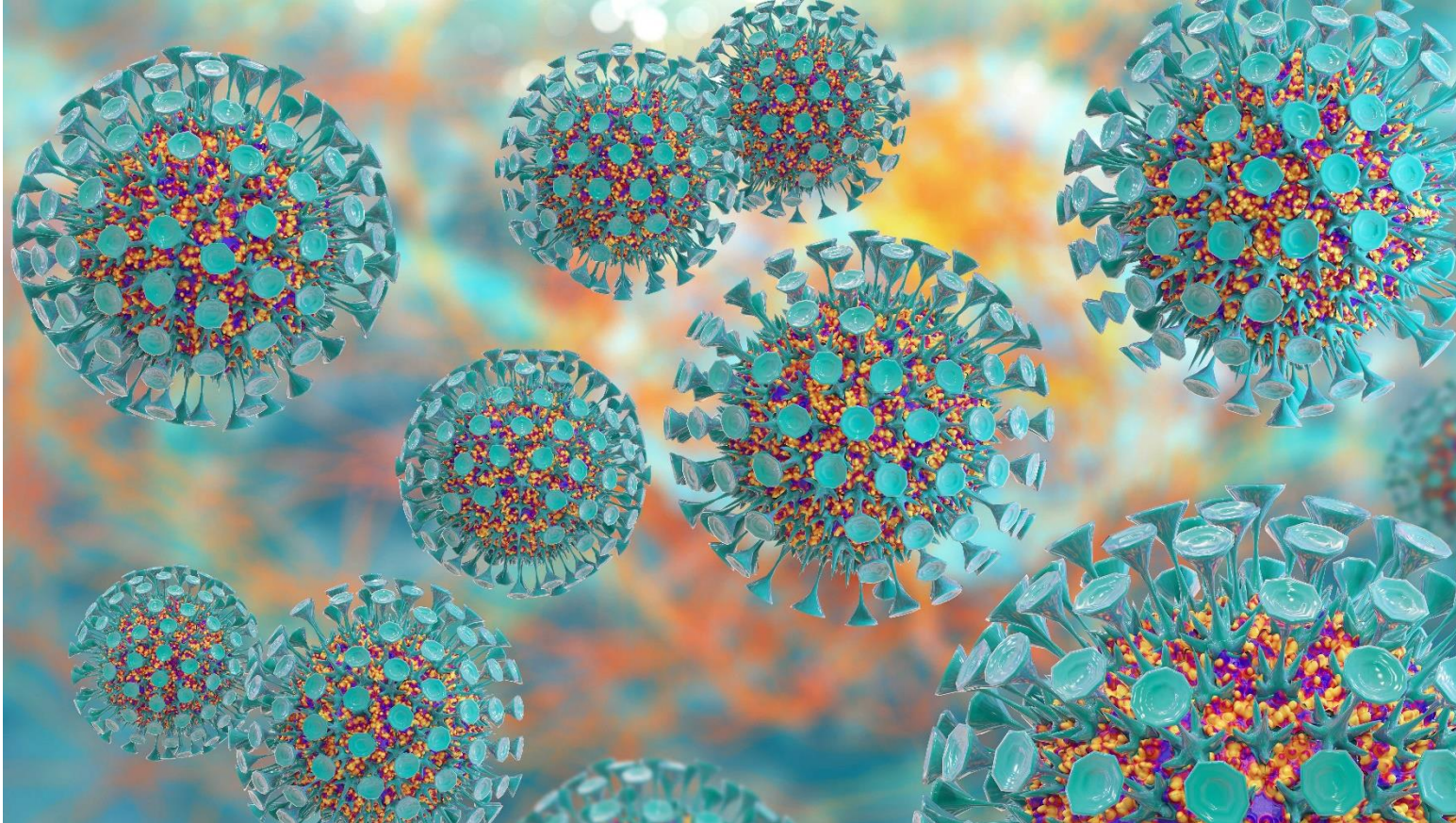

Lecturer: Senior Lecturer, Department
of Molecular Biology and Genetics,
PhD, Smekenov I.T.
Subject: Genetic engineering

(Lecture 10)

Lecture Goal:

To explore vector systems based on animal viruses, focusing on their structure, viral life cycle, and applications in genetic engineering.

Tasks:

1. Describe the characteristics and applications of Simian virus 40 (SV40) as a vector in gene therapy and research.
2. Explain the viral life cycle and how it relates to the use of animal virus vectors in molecular biology.
3. Discuss non-lytic episomal vectors and molecular vectors derived from bovine papillomavirus type I (BPV-1) and adenoviruses, including their advantages and limitations in genetic engineering.

Keywords: *Animal virus vectors, Simian virus 40 (SV40), viral life cycle, non-lytic episomal vectors, bovine papillomavirus type I (BPV-1), adenoviruses, gene therapy, molecular biology, genetic engineering*

Animal viruses

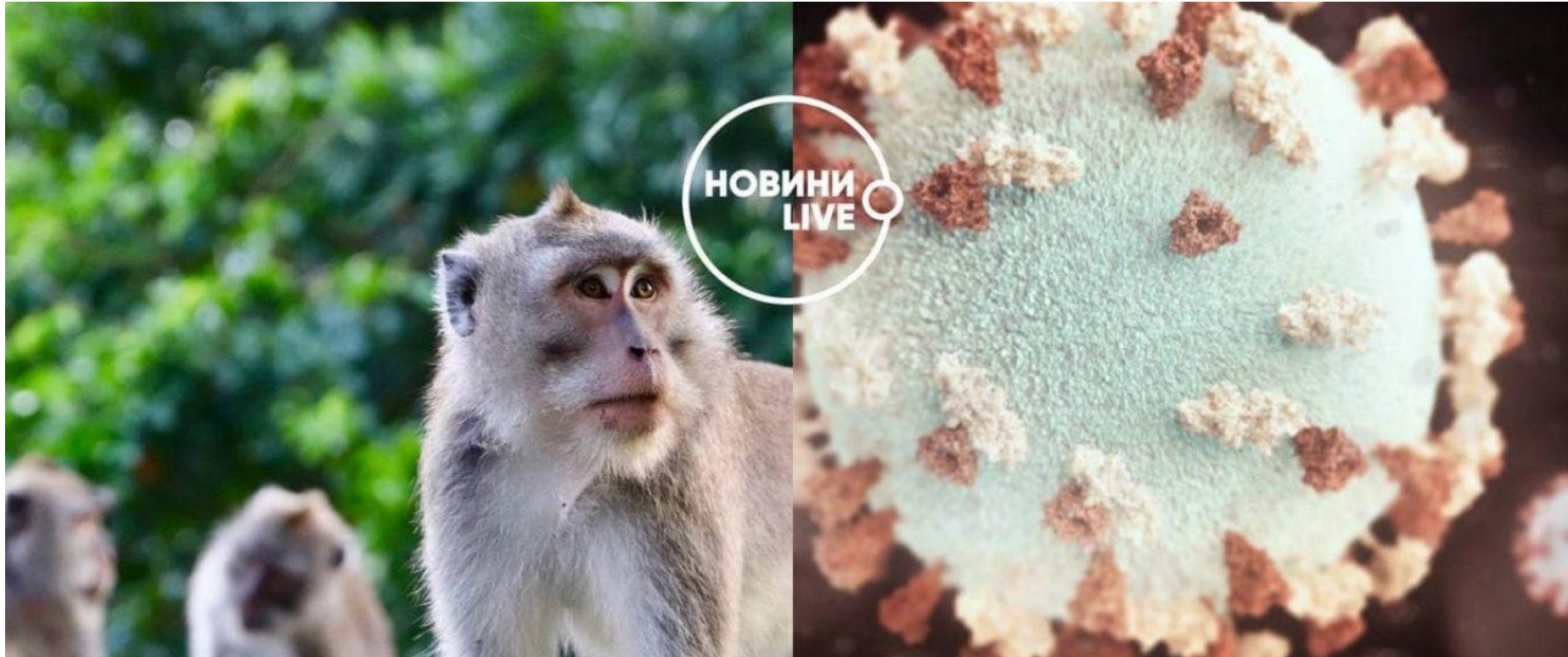

The monkey **virus SV40** is an example of how simple a virus can be and still do its deadly job.

Viruses are **tiny machines** with a single purpose: to reproduce themselves.

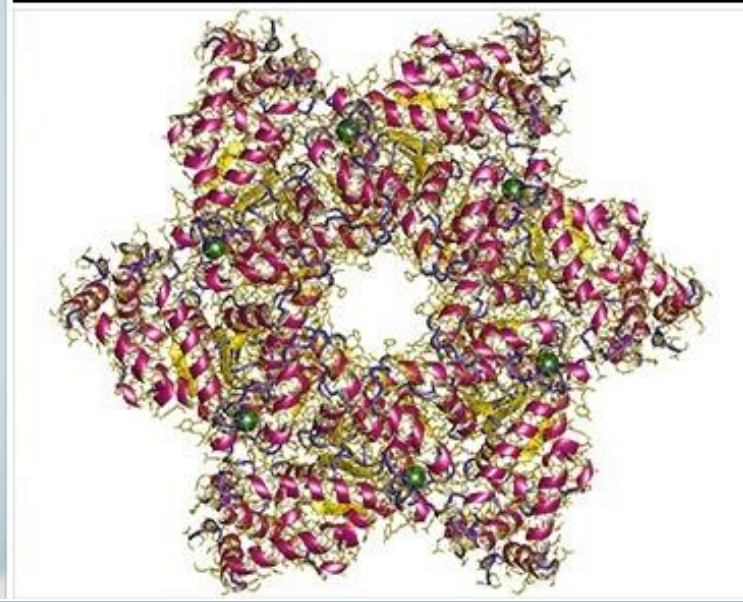
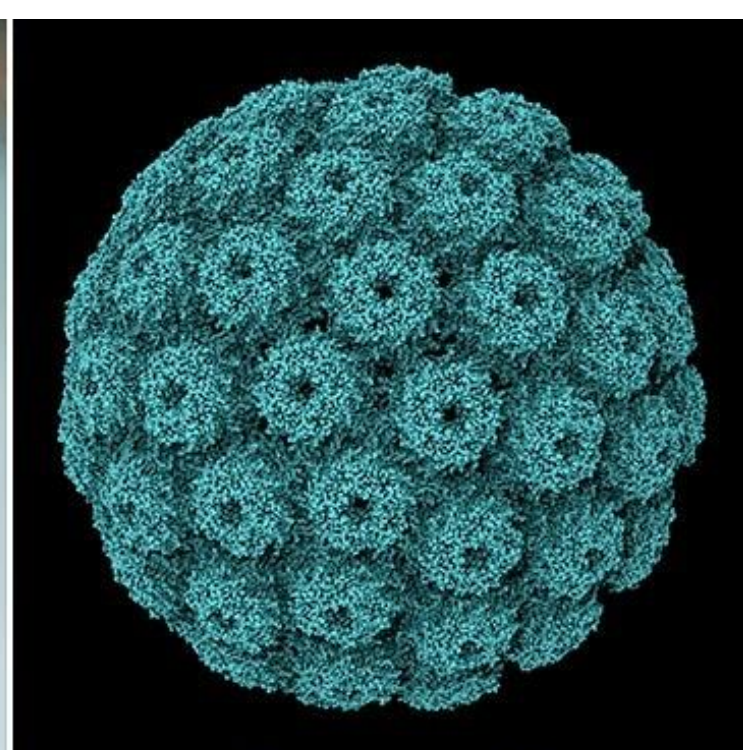

Simian virus 40 (SV40) was discovered in **1960** as a contaminant of *poliovaccines*. Hundreds of millions of people worldwide were inadvertently exposed to infectious SV40 in the late 1950s and early 1960s when they were administered contaminated virus vaccines prepared in rhesus macaque kidney cells.

The **SV40 virus** belongs to the *Polyomaviridae* family of *polyomaviruses*.

Contains 2-stranded circular DNA - 5243 bp.

- **T-Antigen** is a phosphoprotein (708AK): responsible for replication, helicase activity.

- **t-Antigen** has 174AK

Monkey virus SV40 (Green Af.: Vero, CV-1, BSC-1) and its large T-antigen.

- **Simian virus 40 (SV40)** is a nonenveloped virus with an icosahedral capsid symmetry.
- The structural gene products include VP1, VP2, and VP3, that associate within the infected cell to form the 72 capsomers of the viral capsid.
- SV40 large tumor antigen (T-ag) is involved in the initiation of viral replication in permissive hosts and regulates the expression of the late structural gene products that associate to form virions.

➤ For scientists, SV40 has turned out to be an invaluable tool for dissecting molecular details of eukaryotic cell processes. Numerous techniques now commonly used in molecular biology were pioneered in the SV40 system. It continues to serve as a model for basic studies of viral carcinogenesis.

- ✓ It was found in 1962 that SV40 was tumorigenic in newborn hamsters and could transform many types of cells in culture.
- ✓ However, the hamster model provides an excellent way to prospectively test these hypotheses. Even if SV40 plays no role in human tumorigenesis, much can still be learned from the hamster model regarding how viral agents transform mammalian cells.

Physical map of the plasmid

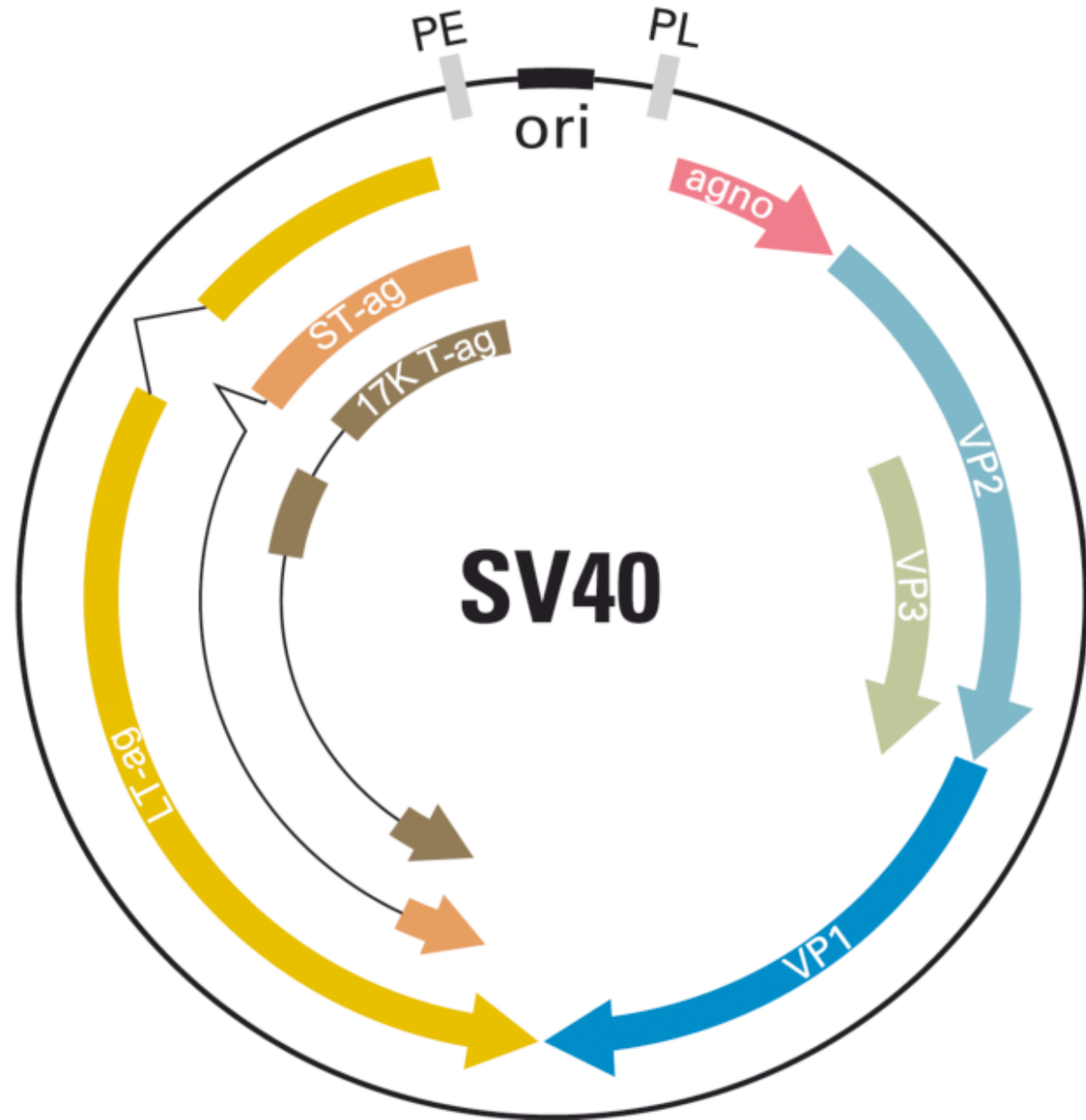
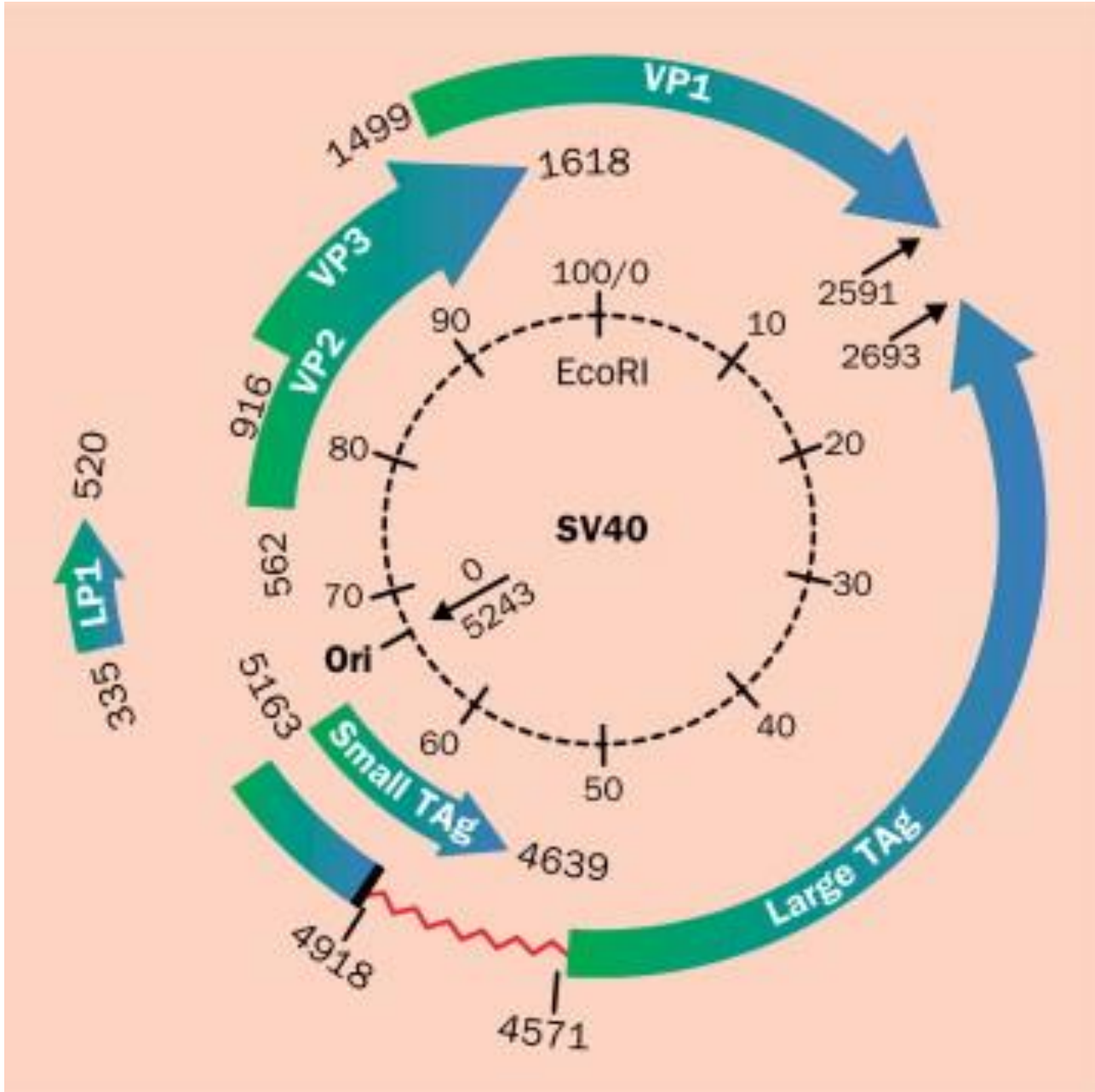

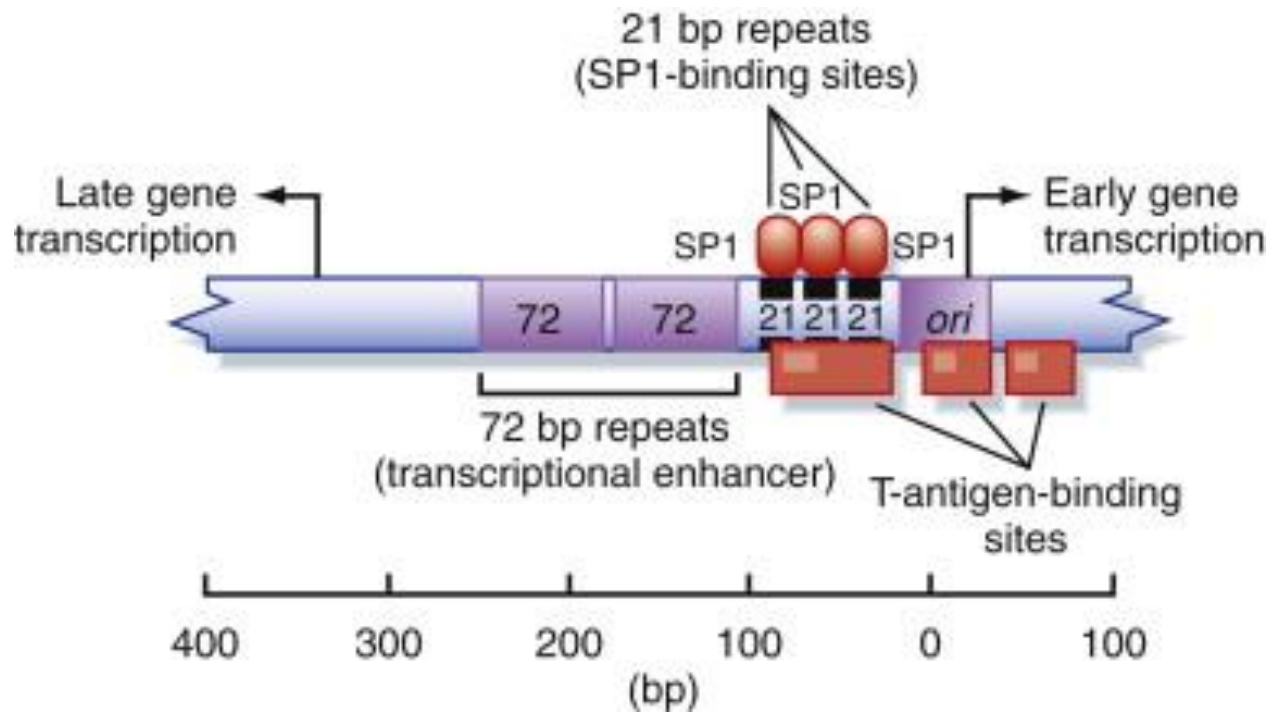

The SV40 virus genome includes a control region responsible for transcription and replication. This region contains various binding sites for cellular and viral proteins, facilitating the regulation of viral gene expression and DNA replication.

1. Early Promoter Region: The TATA-box and the SP1 binding site are involved in the transcription of early mRNA. SP1 is a transcription factor that interacts with the SP1 site to initiate transcription, crucial for early gene expression.

2. Origin of Replication (ori): Located near the SP1 site, this minimal origin of replication spans 65 base pairs and serves as the starting point for DNA replication. The origin is necessary for the replication of the viral genome in host cells.

3. Enhancer Region: Located downstream of the origin, the enhancer contains repeated 72 bp segments that boost transcription levels. This region is critical for enhancing the efficiency of both early and late transcription processes.

4. Late Promoter Region: This region controls the transcription of late mRNA, essential for the synthesis of viral capsid proteins in the later stages of the viral life cycle.

5. T-antigen Binding Sites: These binding sites, labeled as 1, 2, and 3, play a role in the regulation of replication. The T-antigen protein binds here, initiating and controlling the replication of the SV40 genome.

6. Protein Binding Sites (AP1, OBP, AP2, AP3): Specific proteins bind to AP1, OBP, AP2, and AP3, influencing the transcription and replication processes. These sites serve as regulatory elements that interact with host or viral factors to promote viral propagation.



Рис. 14.2. Область контроля транскрипции и репликации генома SV40.

AP1, OBP, AP2, AP3, SP1 — белковые факторы клетки, связывающиеся с соответствующими районами вирусной ДНК

Control Region of Transcription and Replication of the SV40 Genome

•Labels in DNA Sequence:

- AP1 - Binding site for AP1 protein
- OBP - Binding site for Origin Binding Protein
- AP2 - Binding site for AP2 protein
- AP3 - Binding site for AP3 protein

•Boxes and Regions:

- TATA-box
- Early mRNA
- SP1 Binding Site - SP1 is a protein factor that binds to the SP1 site
- Minimal ori (65 bp) - Origin of replication
- Enhancer Region
- Late mRNA
- T-antigen Binding Sites:
 - Numbered as 1, 2, 3

K. Benoist and P. Chambon showed in 1981 that deletion of one of the two sequences (72 bp) does not affect expression.

- P_E has:
- TATA-box (Hogness Block) at a distance of 30 bp from ORI
- 3 direct repeats of 21 bp, at a distance of 115 bp from ORI

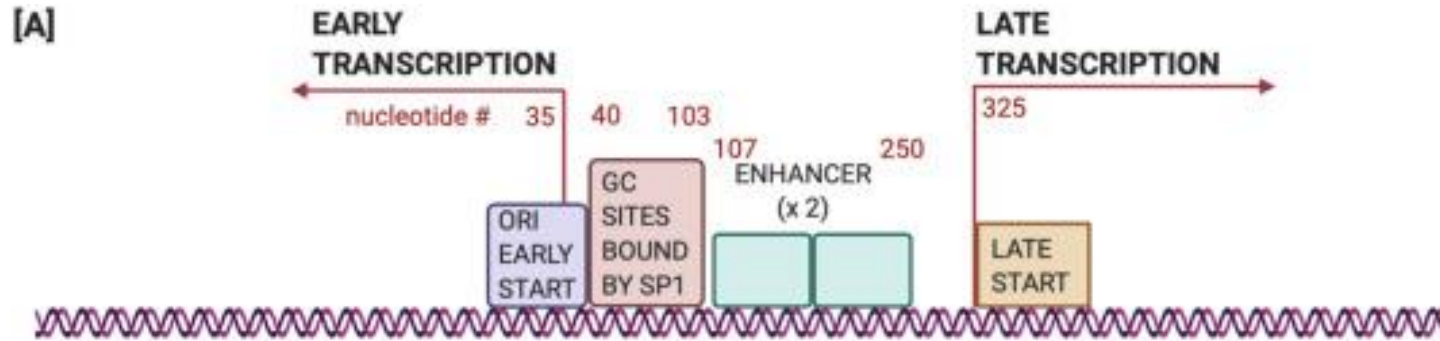

AP1, OBP, AP2, AP3, SP1 - protein factors

Enhanser area 72 + 72 bp.

ORI - cis position

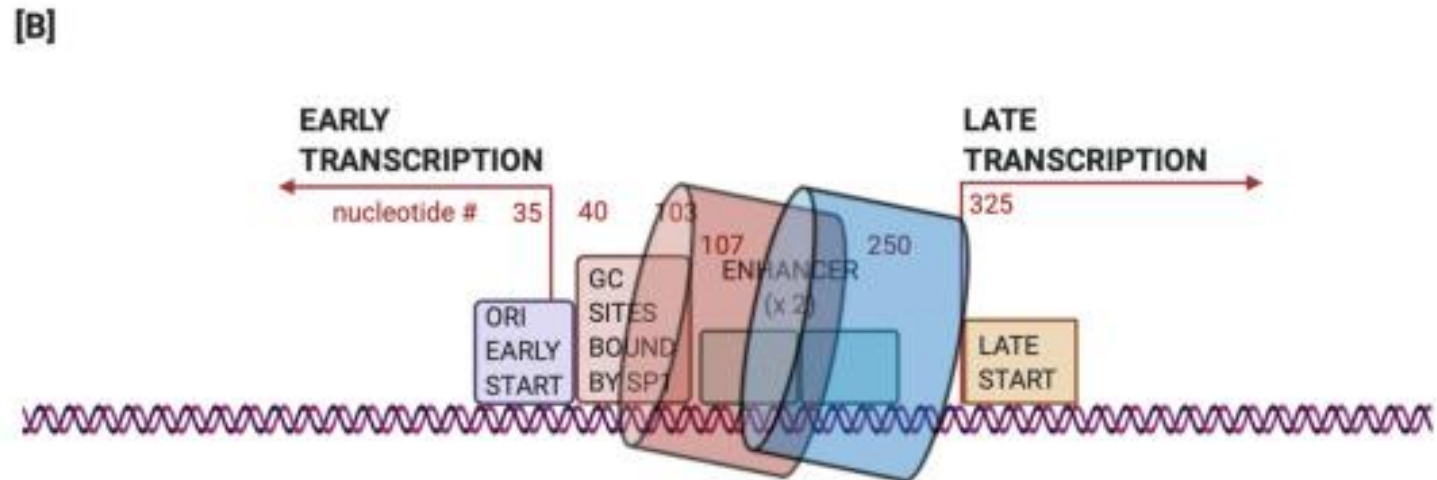

Pre-mRNA is 19S

Alternative splicing of SV40 T antigen

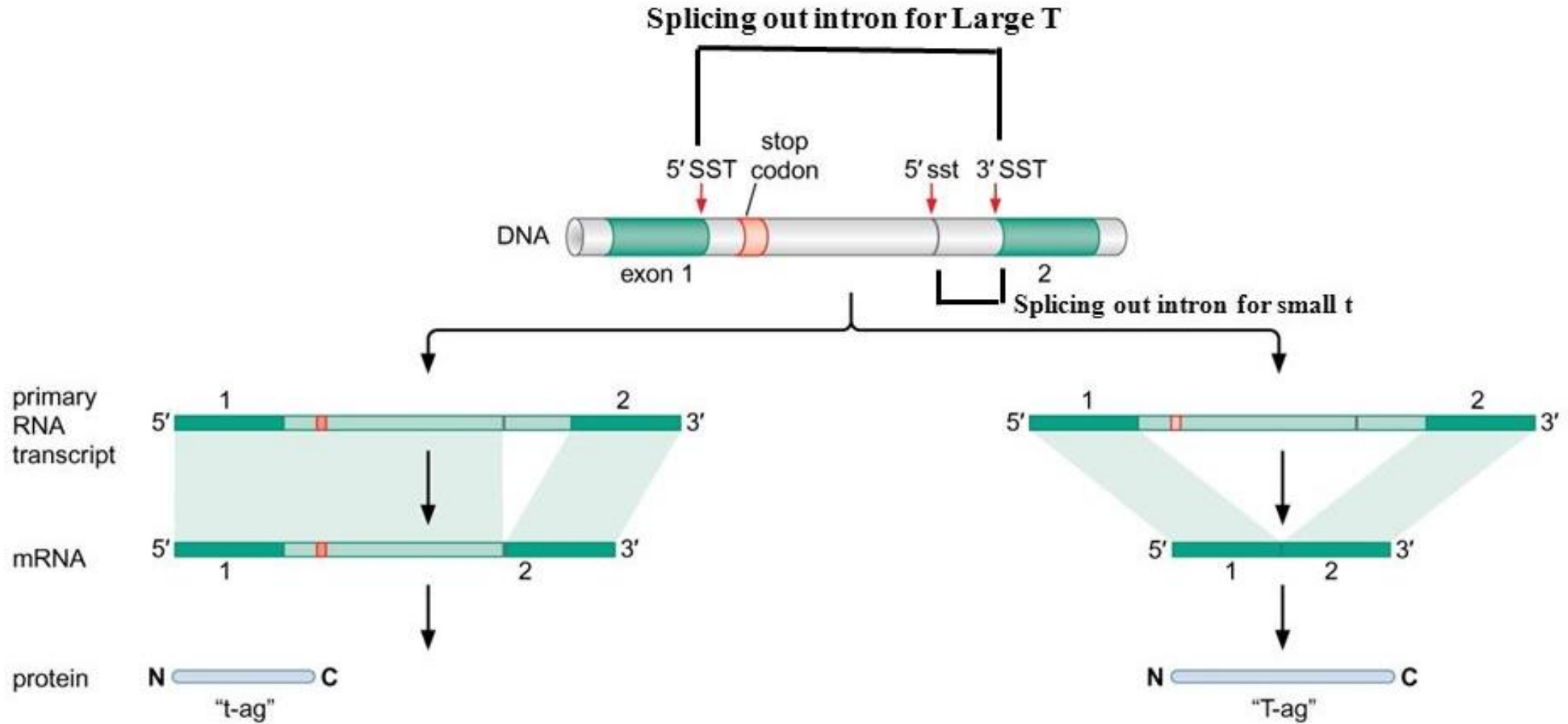

A. Stimulation model

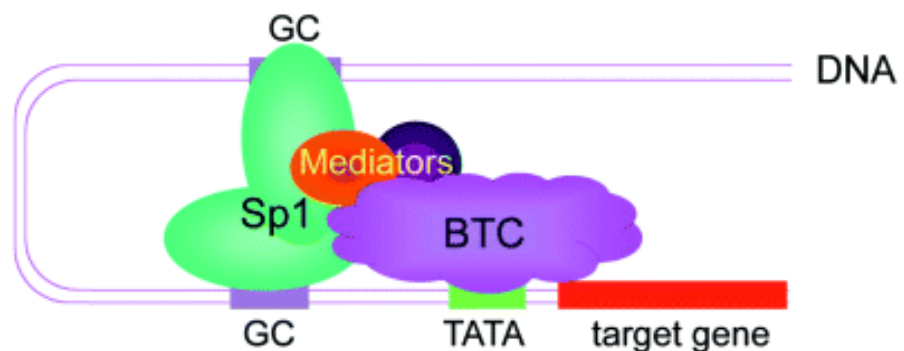

B. Repression model I

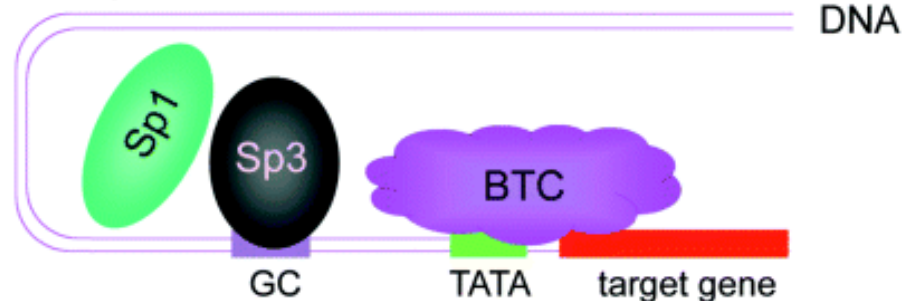

CIS

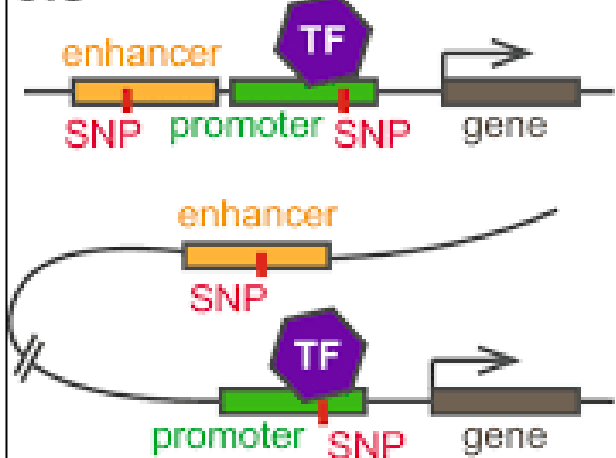

TRANS

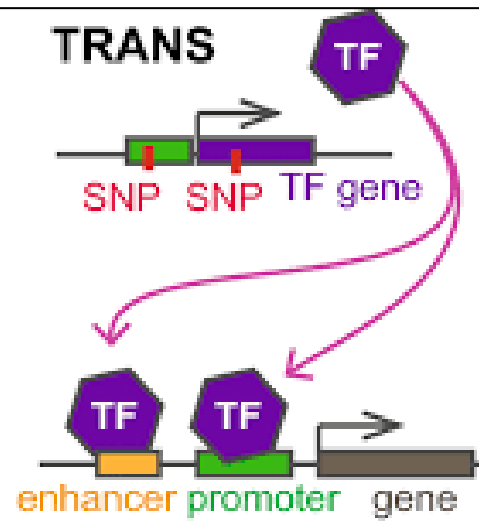

a

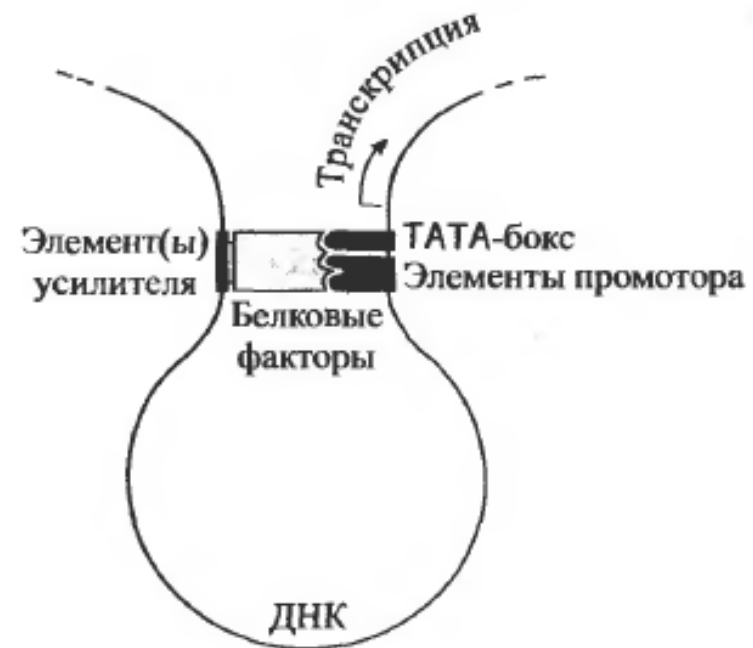

б



Рис. 14.3. Модель функционирования усилителя транскрипции:

a, б — разные ориентации усилителя относительно промотора

- Late pre-mRNA has 16S and 19S coefficients sedimentation.
- Required for reading VP1, VP2 and VP3 proteins.
- 360 capsid subunits
- In vivo in the form of nucleosomes



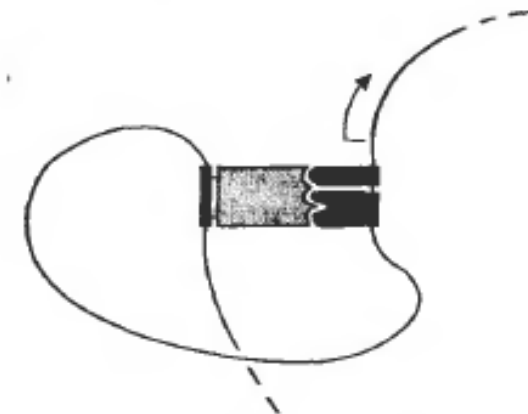
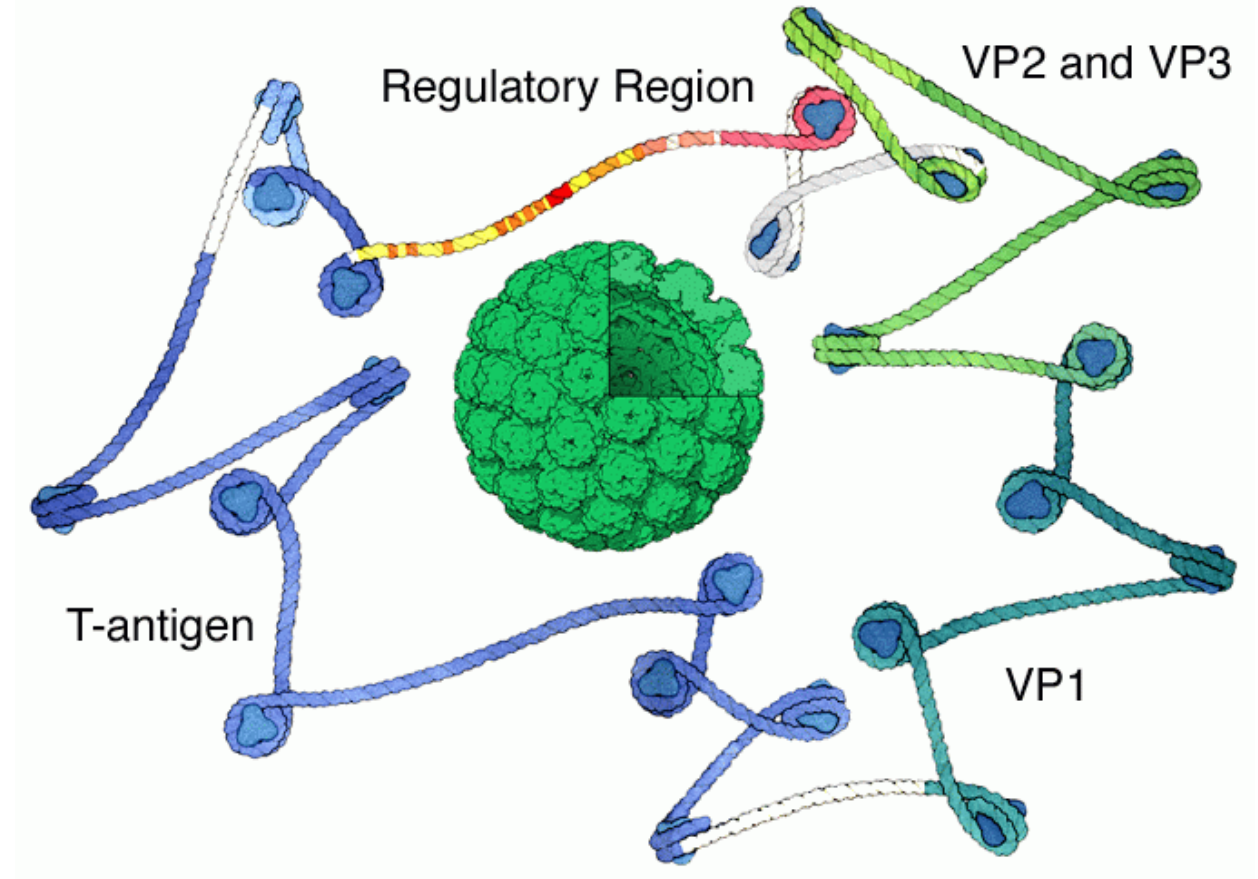
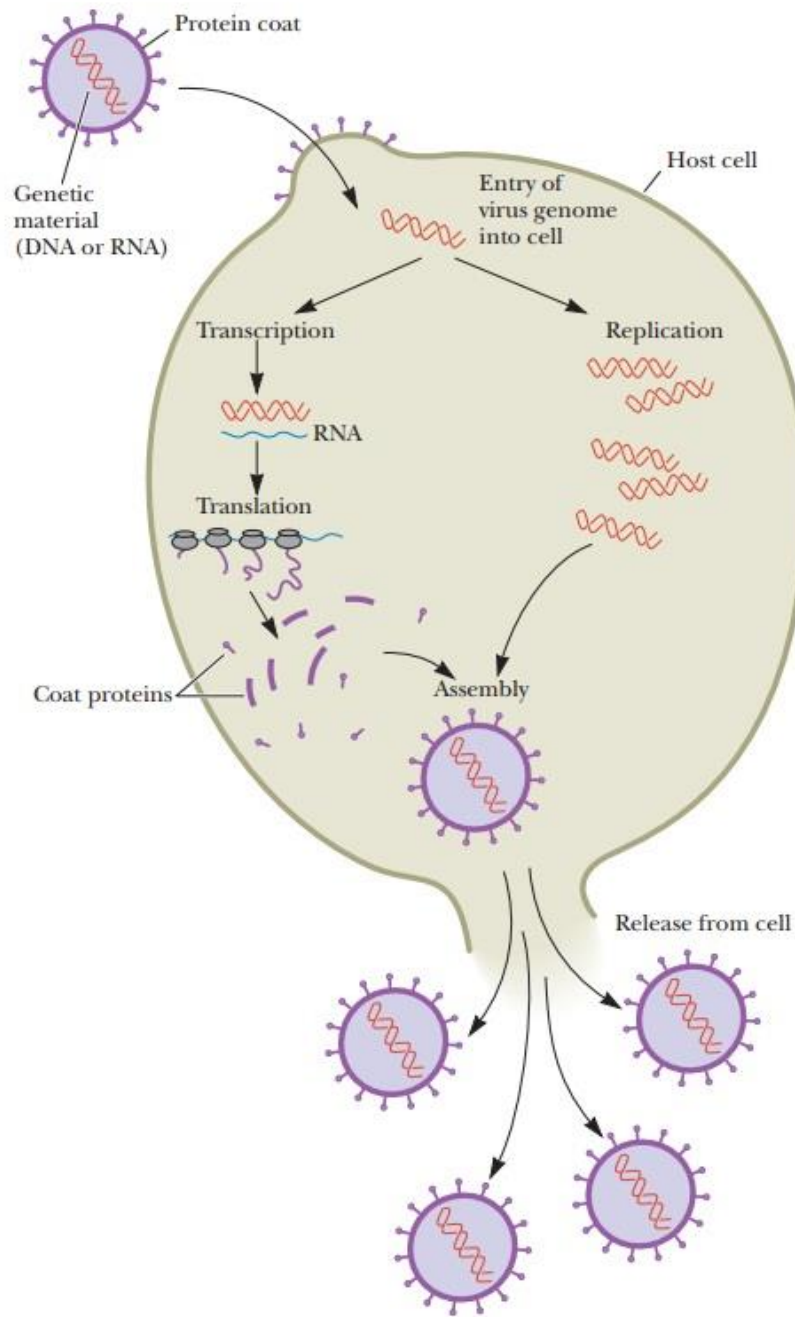
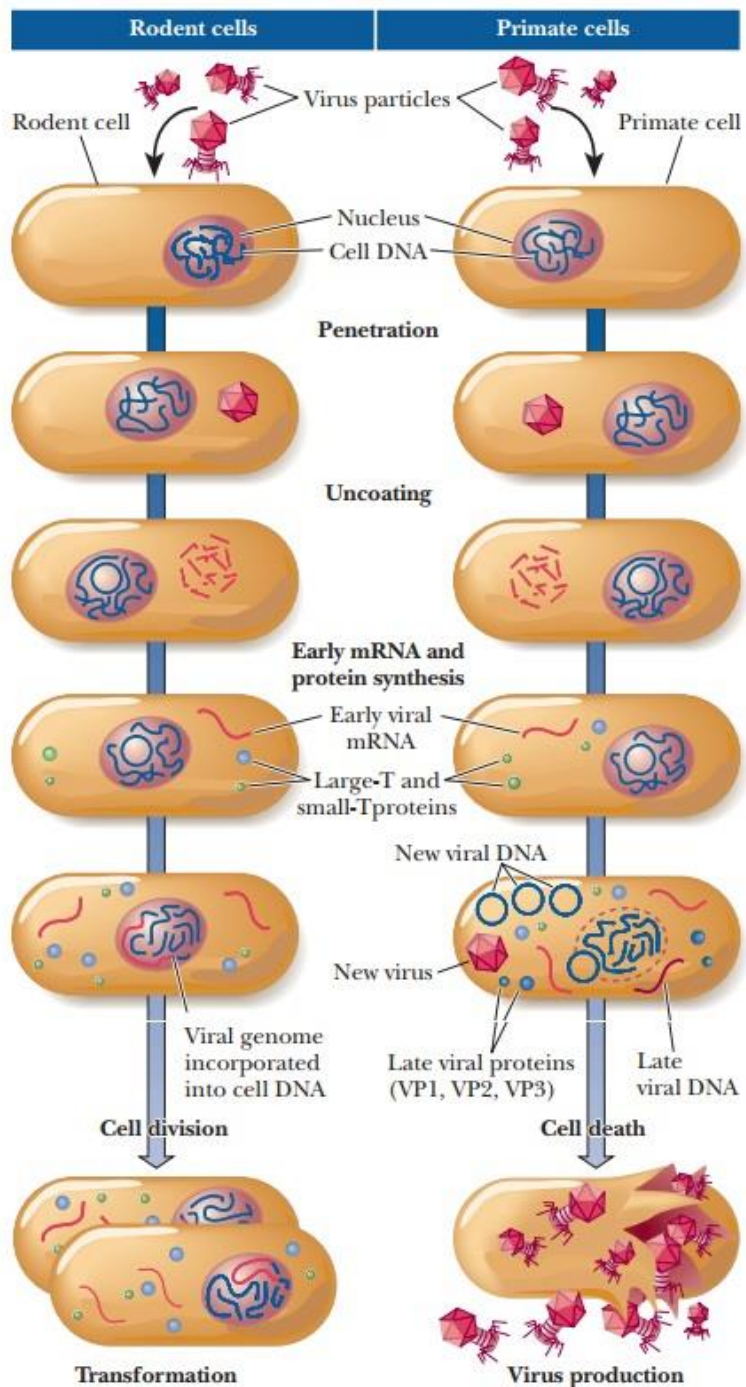

Permissive cells are host cells that are susceptible to the virus and are capable of providing productive virus infection.

In **non-permissive cells**, it integrates into the genome, causing oncogenic transformation of cells.

The Viral Life Cycle

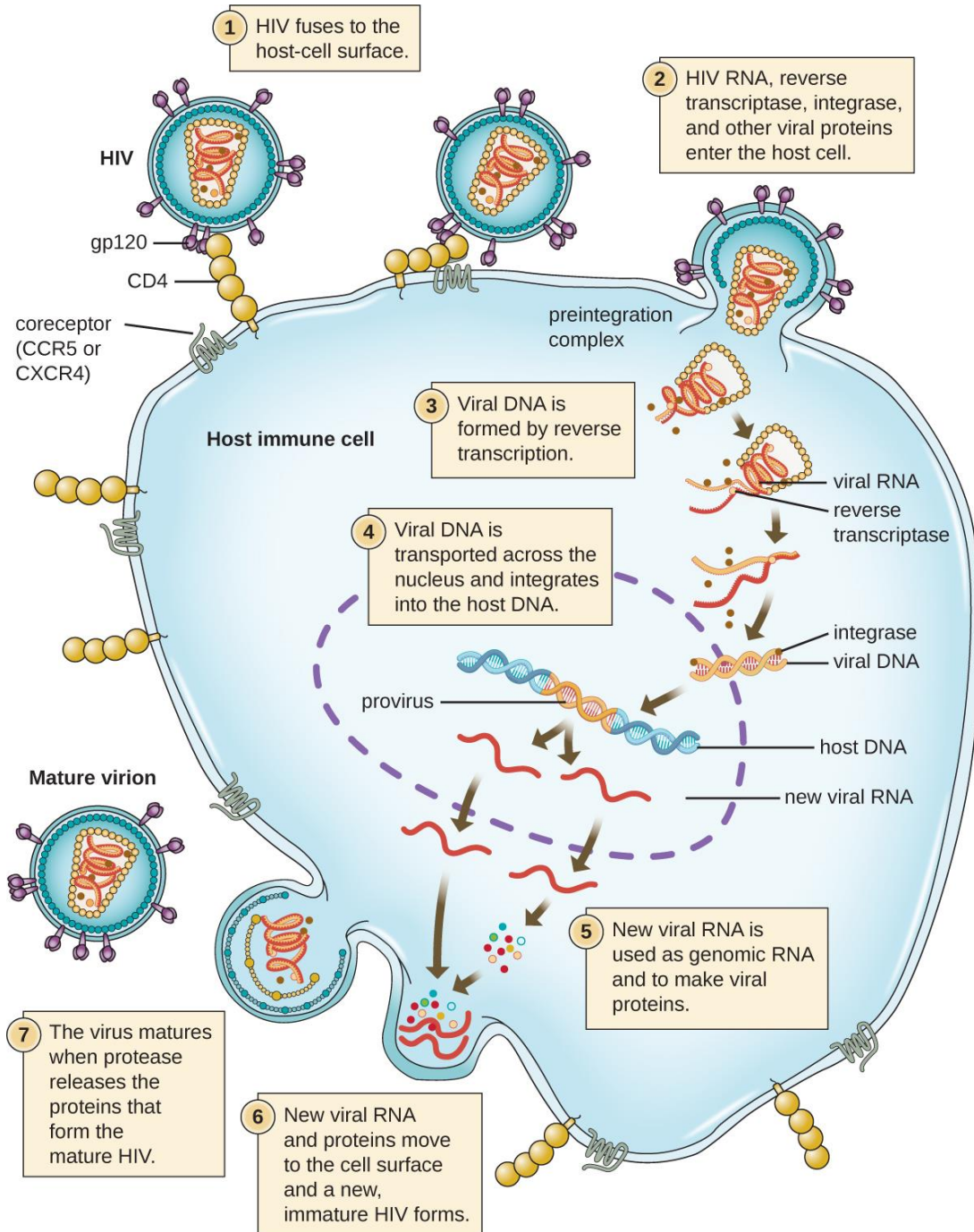

All viruses depend on cells for reproduction and metabolic processes.

By themselves, viruses do not encode for all of the enzymes necessary for viral replication. But within a host cell, a virus can commandeer cellular machinery to produce more viral particles.

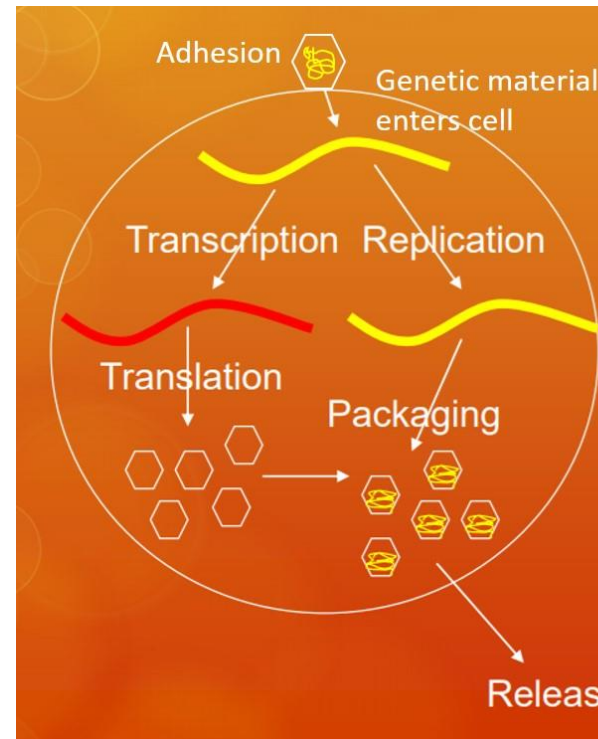

1. Adhesion
2. Insertion of genetic material
3. Synthesis of viral proteins
4. Replication of genetic material
5. Assembly of viral particles
6. Release

A **permissive cell**, a cell susceptible to a virus, capable of ensuring its reproduction.

SV40 virus vectors (lytic vectors)

- 70-100% of the hybrid DNA is needed for packaging.
 - Replacement vectors - late genes are used;
 - Helper Virus;
- The first work on cloning was carried out by P. BERG (1976) - the DNA of the lambda phage was inserted using the connector method.
- And in 1979, he achieved the expression of the rabbit beta-globin eukaryotic gene.



Рис. 14.1. Молекулярно-генетическая организация генома вируса SV40.

Толстые стрелки — последовательности вирусных мРНК, кодирующие соответствующие белки; зигзагообразные линии — интроны молекул мРНК; A_n — участки полиаденилирования.

Цифрами отмечено положение соответствующих точек на физической карте ДНК (в парах нуклеотидов)

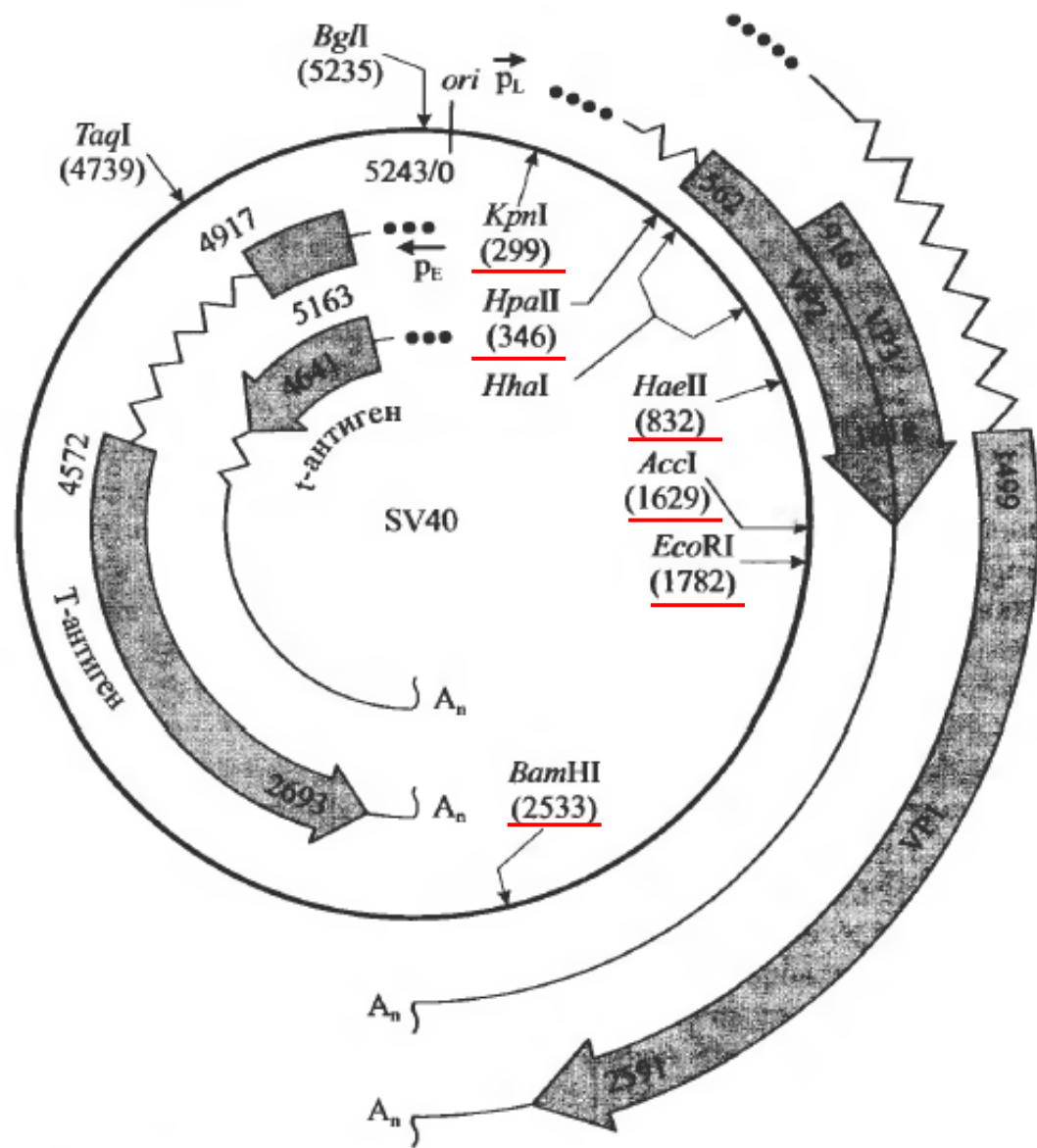

Рис. 14.4. Схема конструирования гибридной ДНК SVGT5-RaβG.



Рис. 14.5. Конструирование гибридного вируса SV40, содержащего хромосомный ген пре-проинсулина крысы *rI₁*. Светлым прямоугольником обозначен интрон

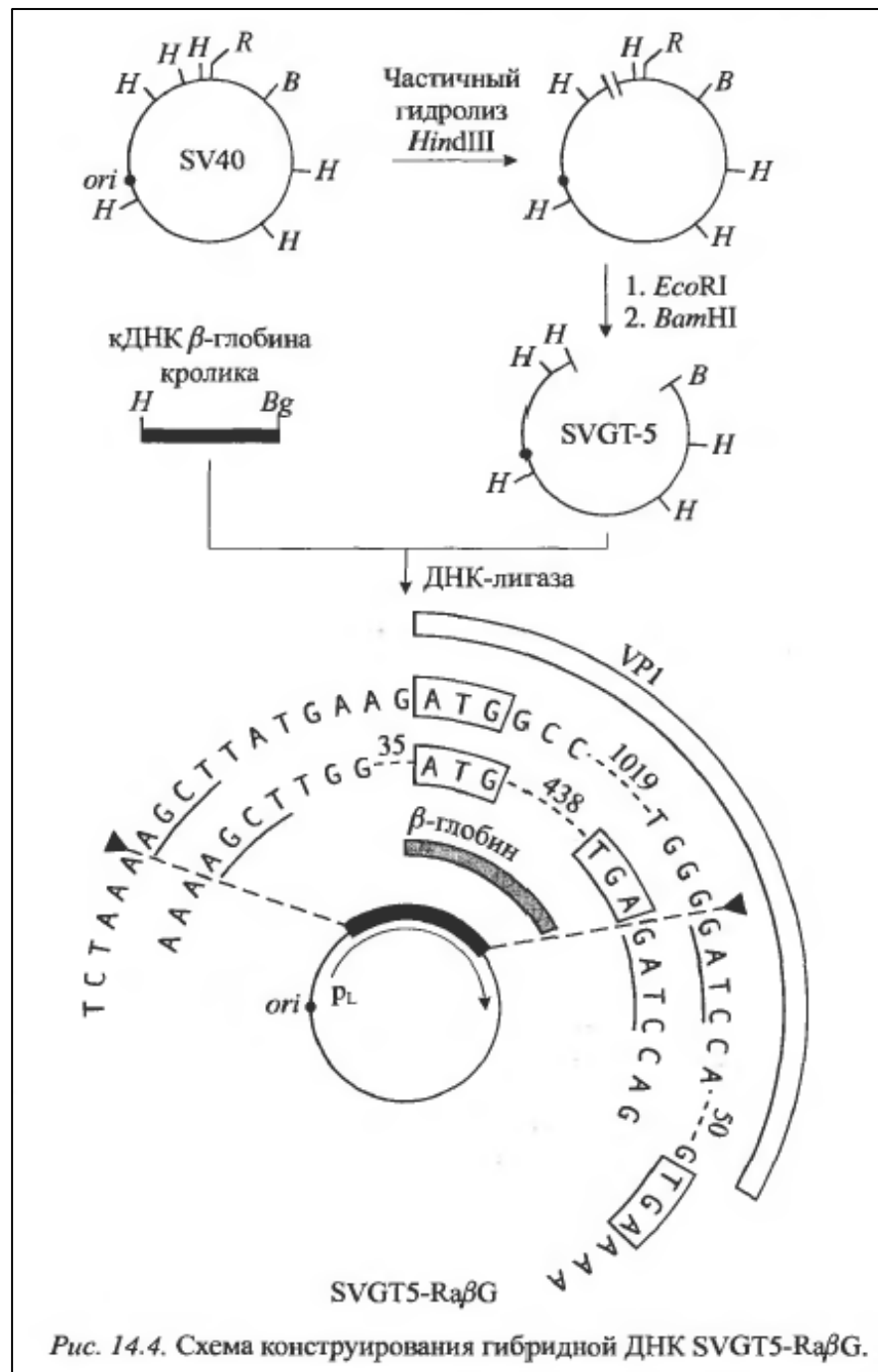

Рис. 14.7. Конструирование генома гибридного вируса LSV-HBsAg

Non-lithic episomal vectors

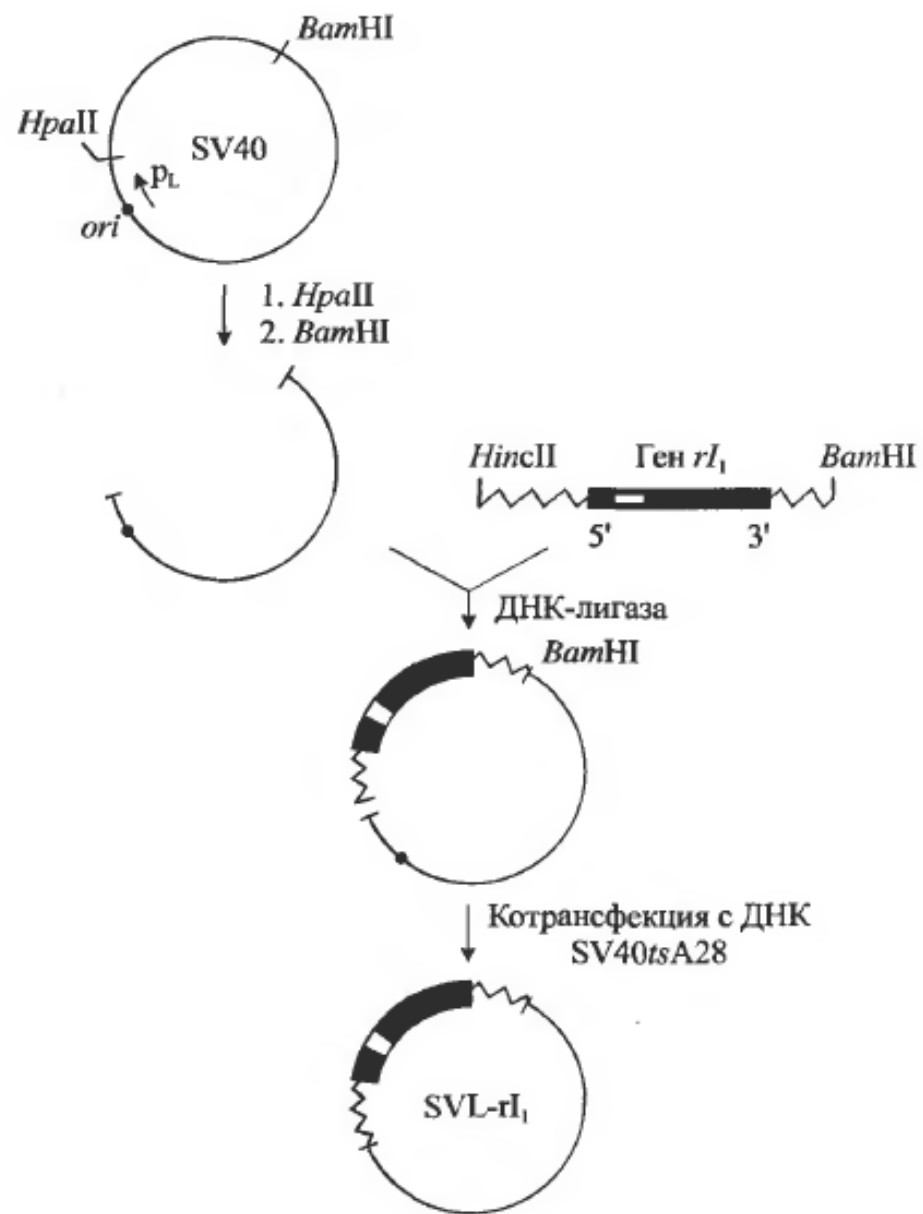
Advantages:

- a large number of plasmids (10^5)
- no lysis
- insert gene is unlimited

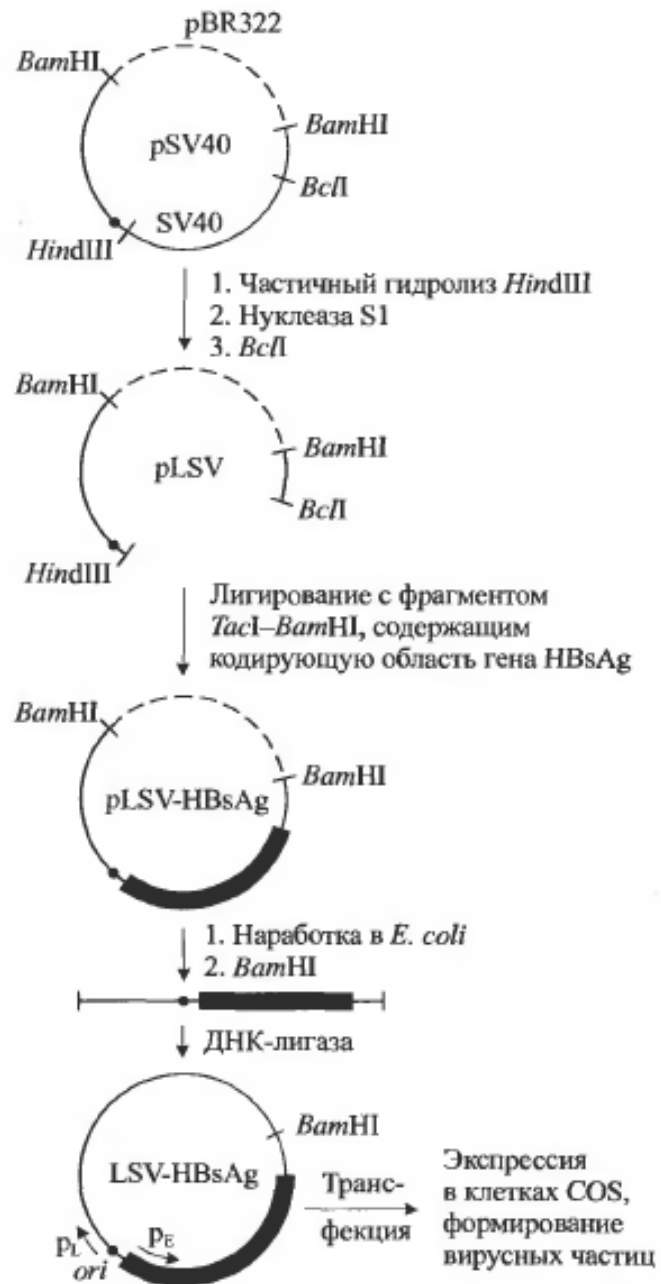
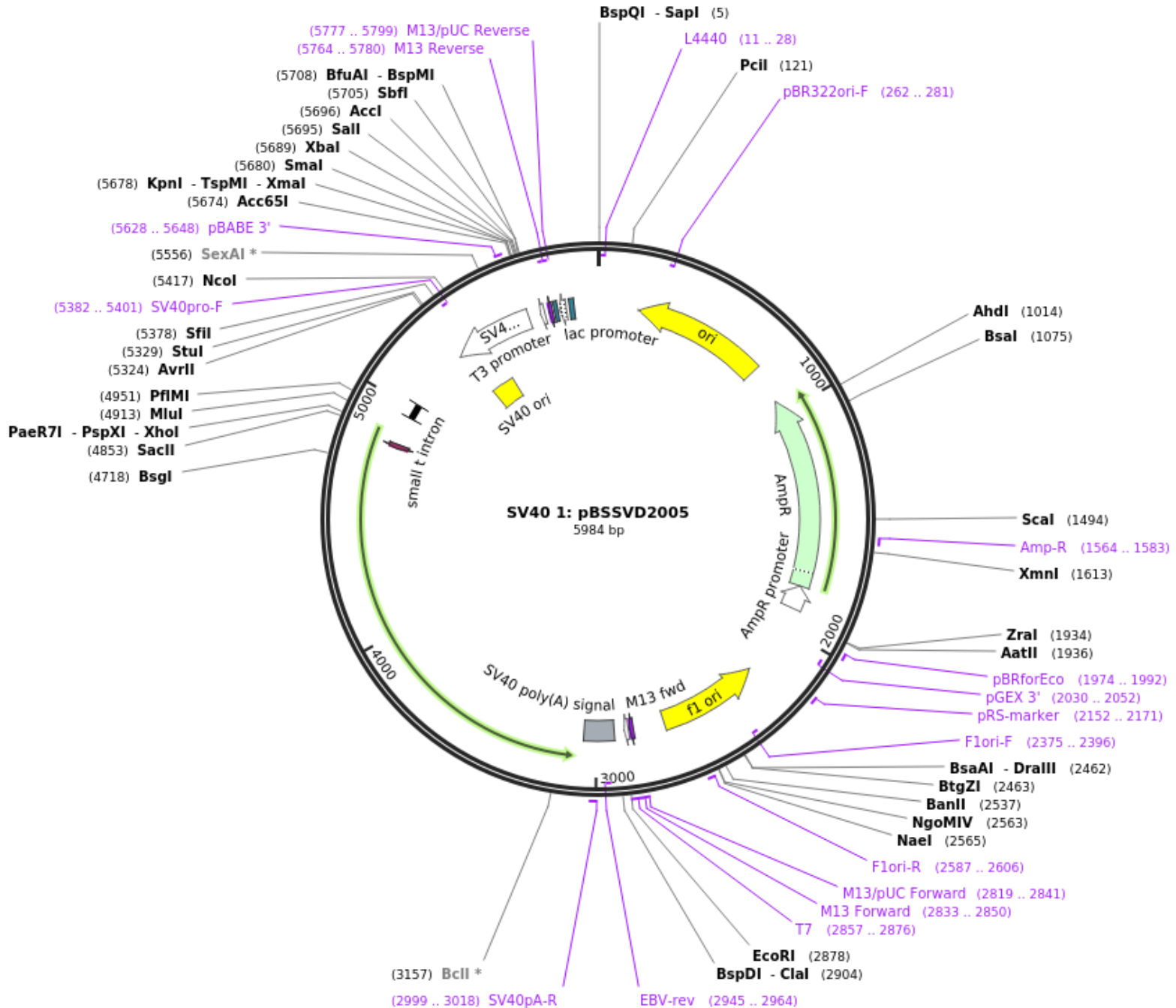

Molecular vectors based on the genome of bovine papillomavirus type I (BPV-1)



Рис. 14.11. Карта генома вируса папилломы быка типа 1.

В скобках указано положение сайтов рестрикции (пп).

LCR — некодирующая область, контролирующая в *cis*-положении транскрипцию вирусных генов

- 200-300 copies per cell without integration;
- - 7946 bp circular dsDNA

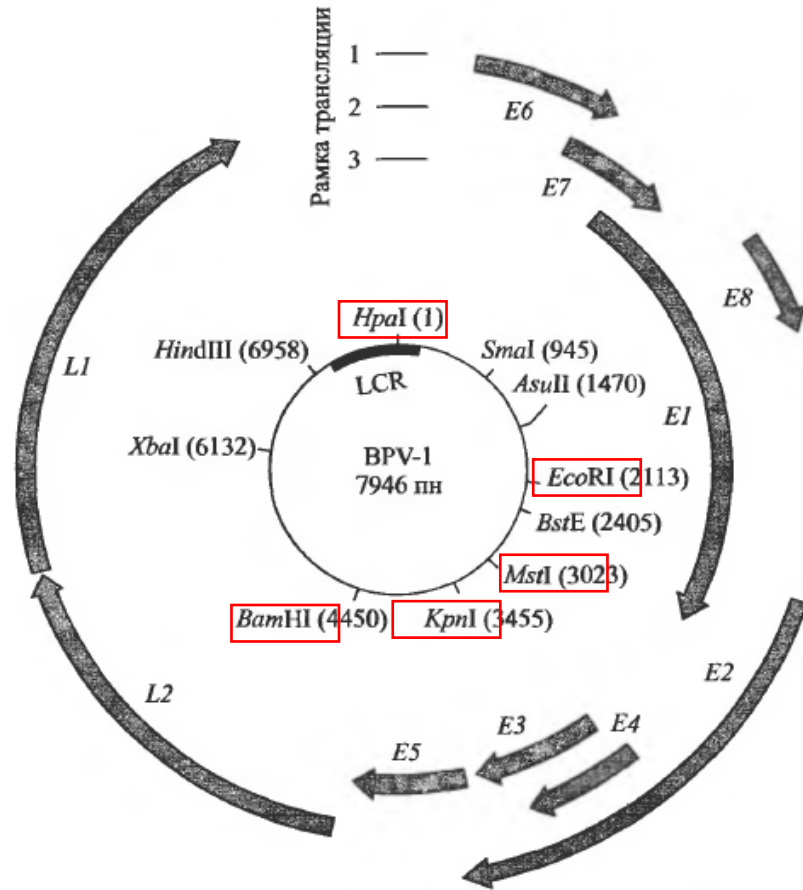
E1, E7	Поддержание плазмидного состояния вирусной ДНК
E2	Транскрипционный модулятор вирусных промоторов
E4	Созревание вирионов
E5, E6	Морфологическая трансформация клеток
L1	Основной капсидный белок
L2	Минорный капсидный белок

- Promoters: 89, 890(E8/E2 – 28kDa), 2443, 3080(E2-TR - 31kDA), 7185, 7250 (**MPL** – papilome/ 10-100 over), 7940 (E2 - 48kDA).
- mRNA – 1-4 kbs (**3:10:1**)

A. Bovine Papillomavirus 1 (7945 bp)

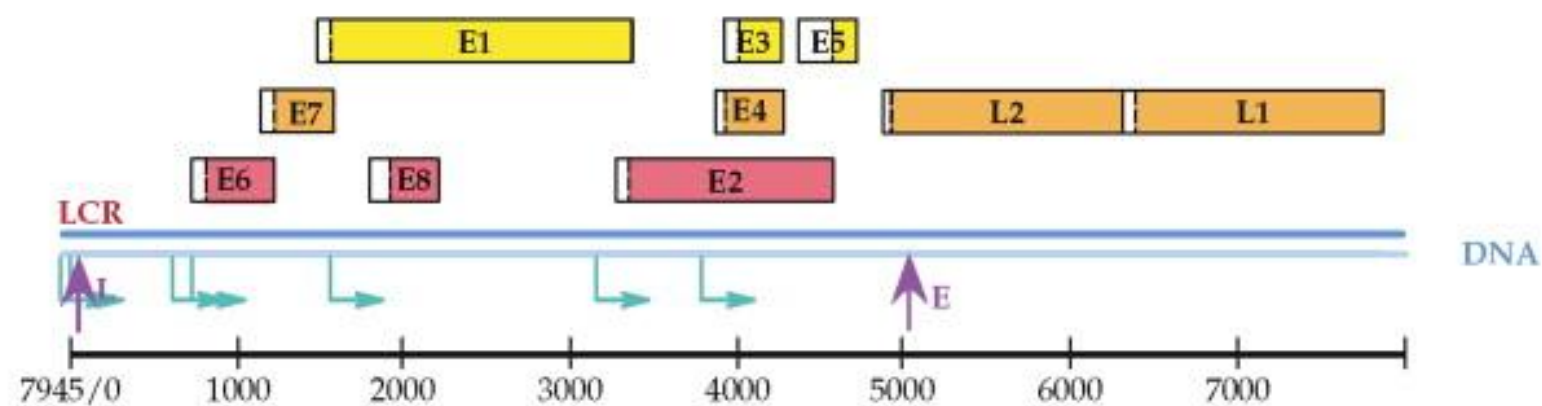

B. Human Papillomavirus 11 (7933 bp)

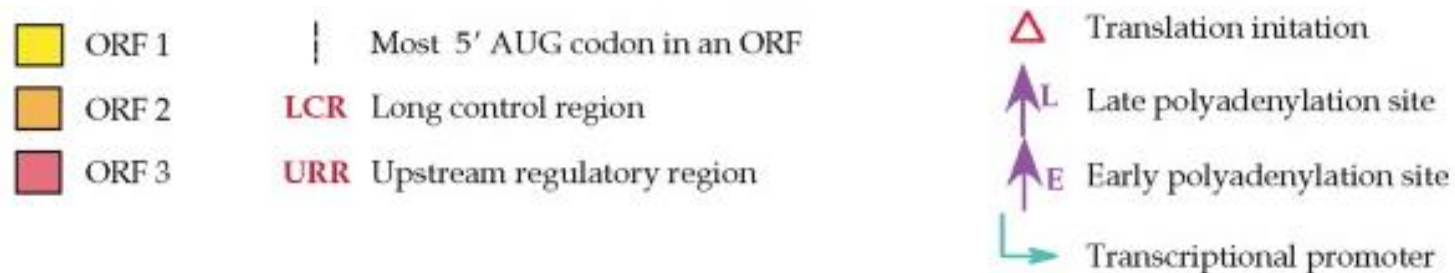
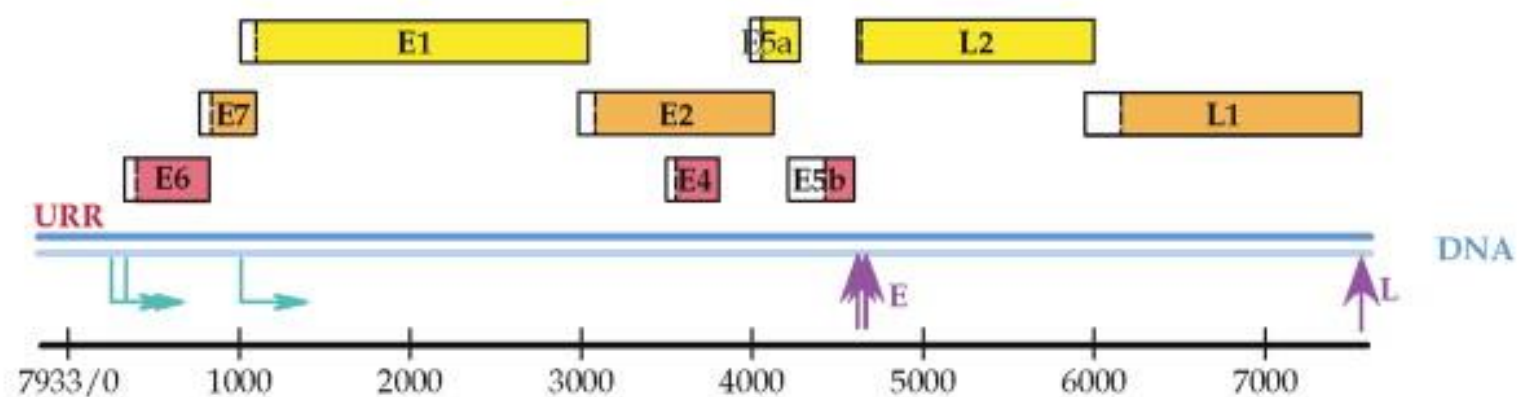

Adenoviruses

- Adenoviruses (Latin *Adenoviridae*) are a family of DNA-containing viruses of vertebrates, devoid of a lipoprotein envelope.
- Adenoviruses have a diameter of 70-100 nm and contain a single double-stranded DNA molecule 36 thousand base pairs long (102-103 bp ITR for Ad2/Ad5).
- Mastadenovirus (mammalian): Ad2/Ad5 (99% homology)
- Aviadenovirus (birds)

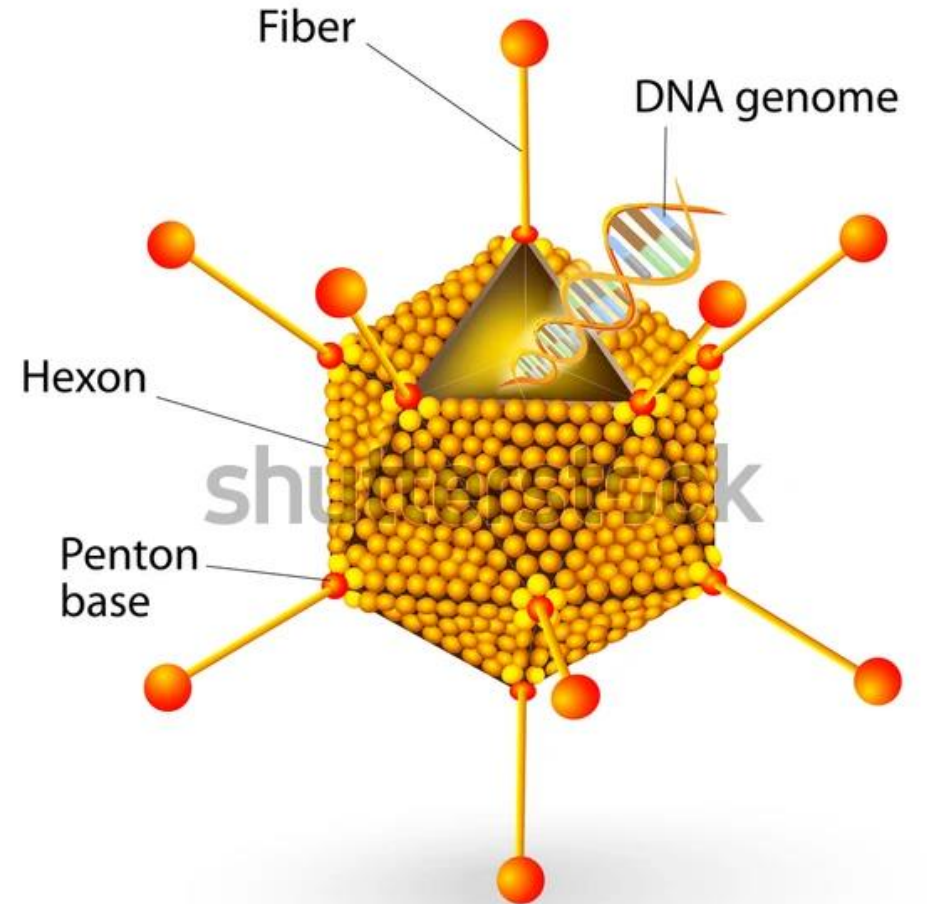

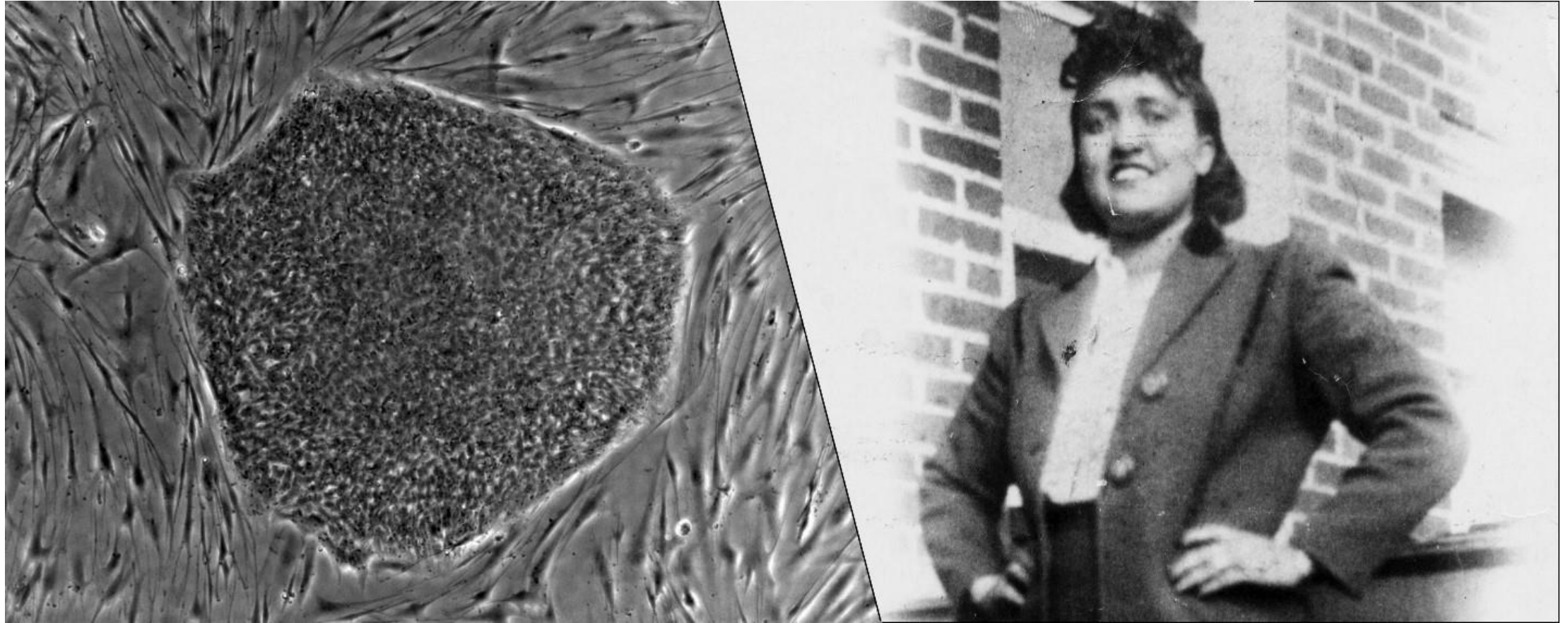

HeLa cells: Origin of this important cell line in life science research

HeLa cells get their name from the person they belonged to: Henrietta Lacks, a Black woman and mother of five who in 1951 got diagnosed with cervical cancer at Johns Hopkins Hospital.

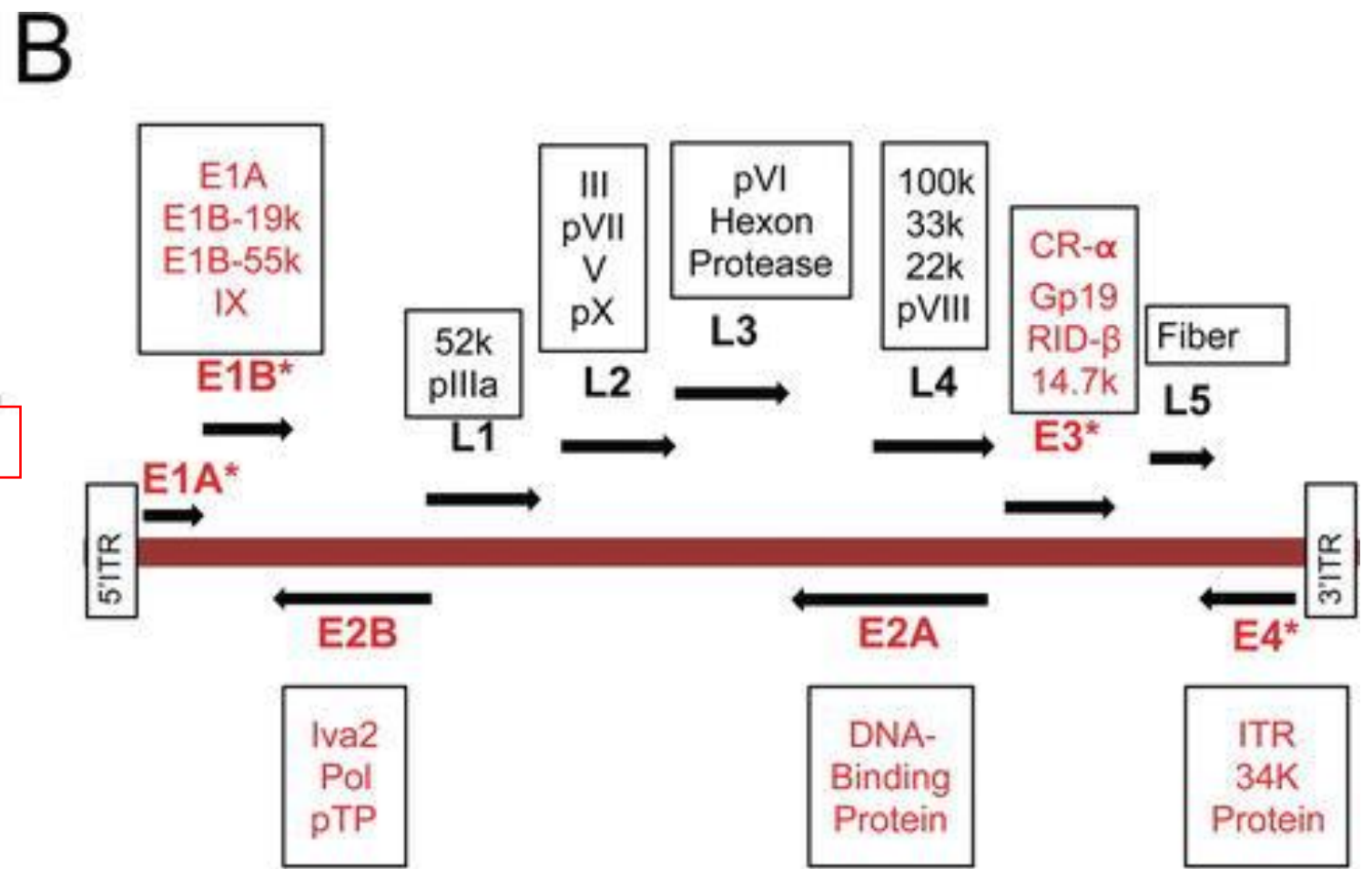
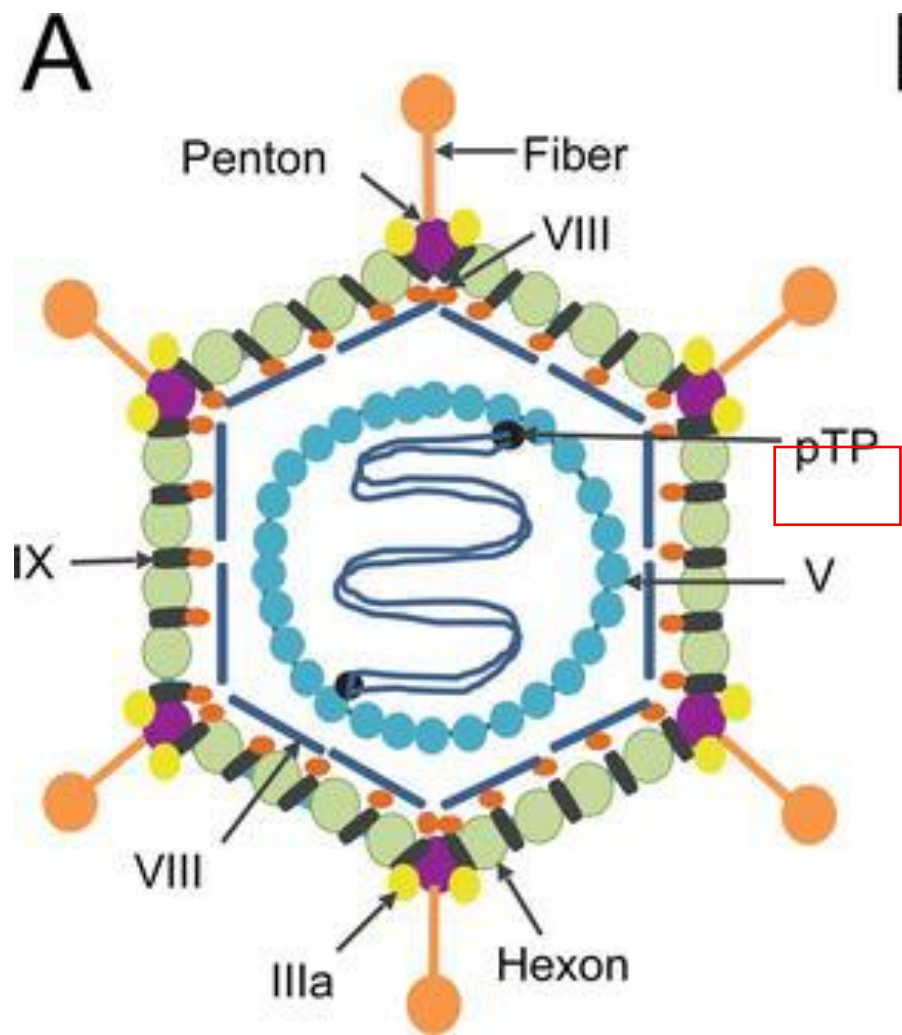

11: 4 – core / 7 – capside
15: nonstructure proteins

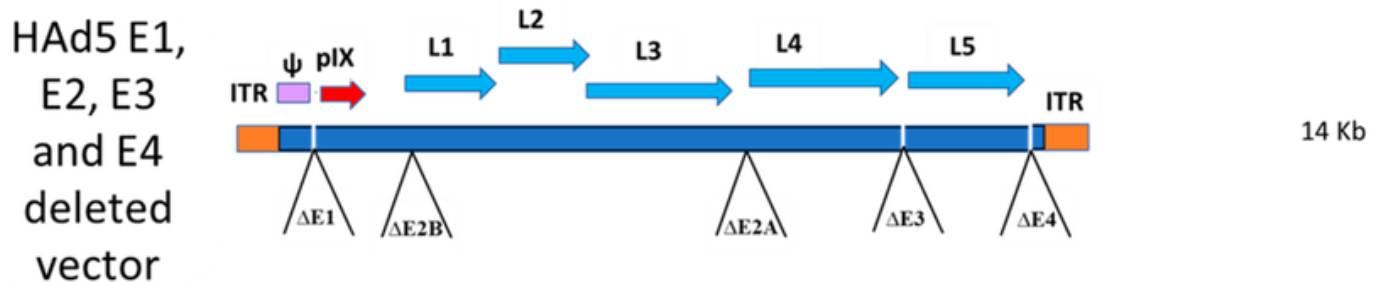
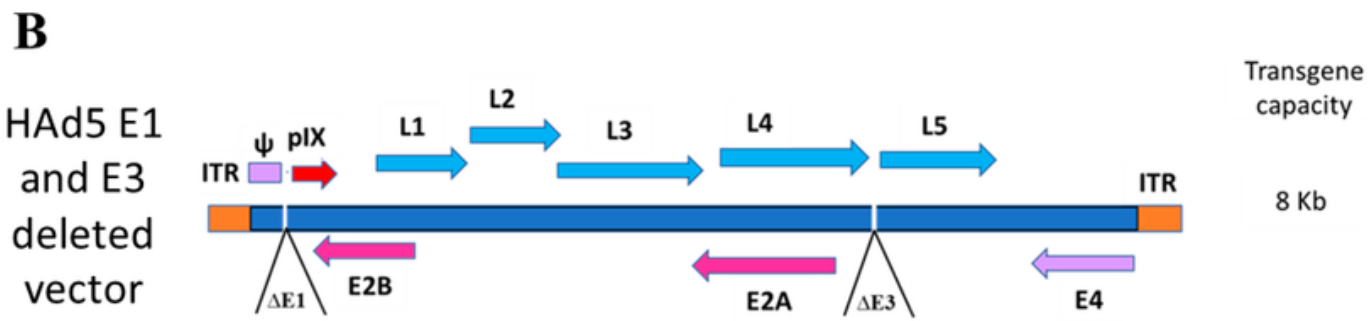
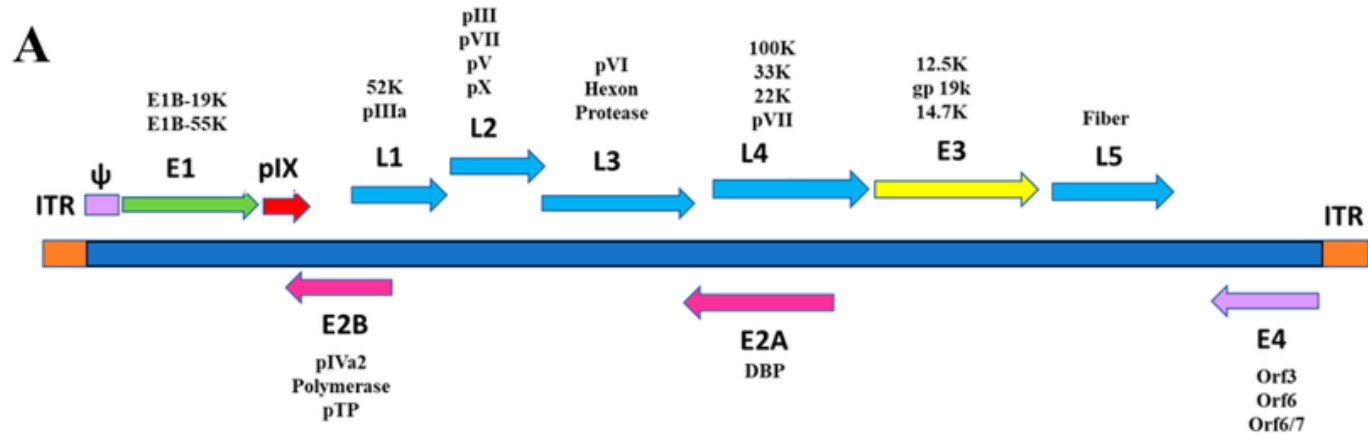

(A) The transcriptional map of human adenovirus type 5 (HAd5). It is composed of early (E) region (E1–E4) genes, which are responsible for genome replication, regulation of the viral transcription, and suppression of the infected cell response to the virus. The late gene transcription units (L1–L5) are expressed late in the viral replication cycle leading to the synthesis of the majority of viral structural proteins.

(B) Diagrammatic representation of HAd5 vaccine vectors. The upper panel represents the vector genome containing the E1 and E3 deletions, and the lower panel shows the vector genome organization consisting of the E1–E4 deletions to increase the insertion capacity of foreign gene cassette.

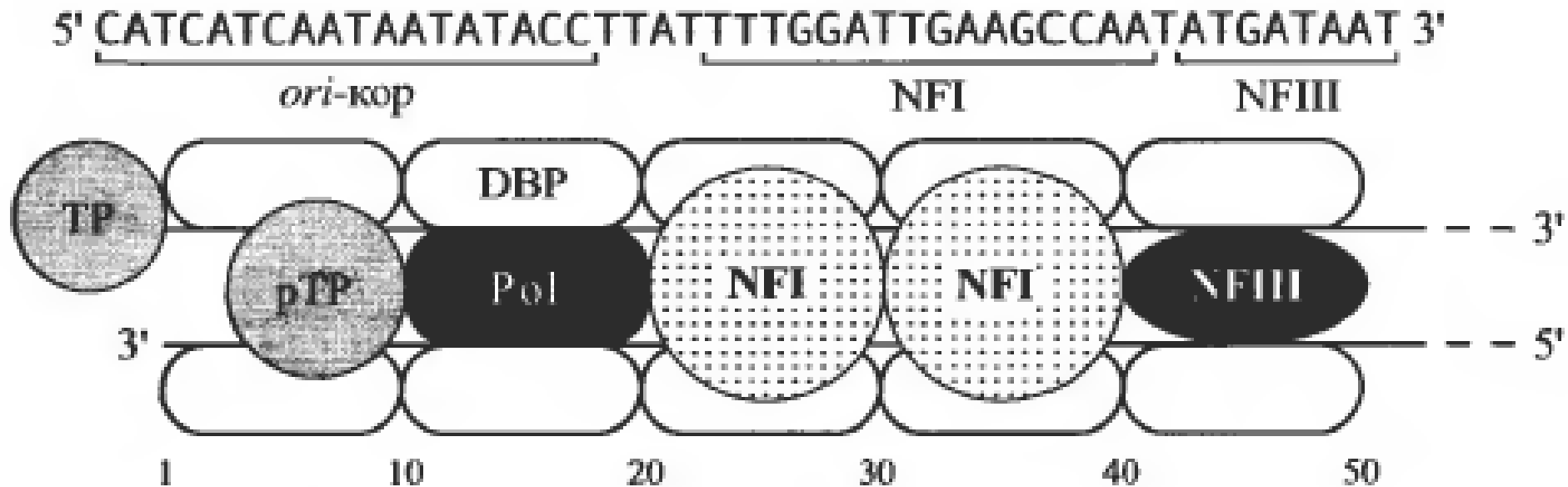

Scheme of DNA-protein and protein-protein interactions in the region of initiation of adenovirus DNA replication.

- The sequence of the DNA chain covalently bound to the TP protein is shown. The square brackets indicate the DNA domains to which the corresponding proteins bind